

*Syscomp Electronic Design Limited*

# WGM-201 Waveform Generator Manual

<http://www.syscompdesign.com>

Version 1.05

April 18, 2011



## Revision History

Version	Date	Notes
1.00	Oct 2009	First revision
1.01	May 2010	Added section on arbitrary waveform Added directions for waveform sync
1.02	May 2010	Added command information
1.03	Dec 2010	Added sweep modes
1.04	Mar 2011	Added WaveMaker reference Added Triggered Tone BurstExample
1.05	Apr 2011	Added more command information

## Contents

<b>1</b>	<b>Overview</b>	<b>1</b>
1.1	Specification . . . . .	1
1.2	Basic Operation . . . . .	2
1.3	Graphical User Interface . . . . .	2
1.4	Manual Frequency Setting . . . . .	3
<b>2</b>	<b>Frequency Sweep</b>	<b>3</b>
2.1	Manual sweep . . . . .	4
2.2	Automatic Sweep . . . . .	5
2.2.1	Continuous Sweep . . . . .	6
2.2.2	Sweep Trigger Output . . . . .	6
2.2.3	Sweep Trigger Input . . . . .	6
<b>3</b>	<b>Tone Burst</b>	<b>7</b>
3.1	Triggered Tone Burst . . . . .	7
<b>4</b>	<b>Pulse Generator</b>	<b>9</b>
<b>5</b>	<b>Pattern Generator</b>	<b>10</b>
5.1	Creating a Digital Pattern . . . . .	10
5.2	Pattern File Format . . . . .	11
<b>6</b>	<b>Counter</b>	<b>13</b>
<b>7</b>	<b>Arbitrary Waveform</b>	<b>13</b>
7.1	Low and High Frequency Settings . . . . .	13
7.2	Detail in Arbitrary Waveforms . . . . .	14
7.3	Waveform Editor . . . . .	14
<b>8</b>	<b>Synchronizing Two Generators</b>	<b>14</b>
<b>9</b>	<b>Commands</b>	<b>15</b>
9.1	Setting up the Terminal . . . . .	15
9.2	Command Listing . . . . .	15

<b>10 Rear Panel Connector</b>	<b>20</b>
10.1 Rear Panel Connector Mating Plug . . . . .	21
<b>11 Creating an Arbitrary Waveform</b>	<b>22</b>

## List of Figures

1	WGM-201 Graphical User Interface . . . . .	3
2	Minimum User Interface . . . . .	4
3	Sweep Mode Control Panel . . . . .	5
4	Trigger Controls Panel . . . . .	7
5	Tone Burst Oscilloscope Display . . . . .	8
6	Pulse Generator Control Panel . . . . .	9
7	Pattern Generator Control Panel . . . . .	10
8	Pattern Editor . . . . .	11
9	Pattern Demonstration . . . . .	12
10	Counter Panel . . . . .	13
11	Synchronized Waveforms . . . . .	15
12	WGM-201 Rear Panel Connector Pinout . . . . .	21

# 1 Overview

The Syscomp WGM-201 Waveform Generator is a general-purpose waveform generator, 8 bit digital word generator and general purpose counter. With many advanced features, it is useful for the teaching, development and debugging of electronic circuits.

The WGM-201 is one of a series of instruments from Syscomp Electronic Design. All instruments use a computer host for the graphical user interface (GUI) control panel, and connect with the hardware via a USB virtual COM port. The software is Open Source and runs under Windows, Linux and Mac operating systems. The generator hardware receives power from the host PC via the USB connection so that no other power source is required.

The generator hardware is capable of producing a variety of waveforms. Sine, square, triangle and ramp (sawtooth) waveforms are installed in the firmware. In addition, an arbitrary waveform can be created and downloaded into the generator. The generator can produce these waveforms at frequencies between 0.1Hz and 10MHz with variable amplitude and variable DC offset.

The waveform frequency is derived from a crystal oscillator, so it is precise and stable. The waveform amplitude is determined by digital-analog conversion of digital values. The amplitude stability is determined by internal voltage reference source and 1% resistor values.

A PC host displays a graphical user interface for the function generator with frequency readouts, sliders, clickable buttons and various other controls. The PC connects to the function generator hardware via a USB cable so that no other power source is required.

A Graphical User Interface (the *GUI*) program for operating the waveform generator is provided on the accompanying CDROM. The program is written in the Tcl/Tk language. It is completely Open Source, so it may be modified and distributed freely.

The USB interface emulates a serial port so that it may be accessed as a serial port device from a host computer. Any language that can talk to a serial port can send commands to and receive data from the hardware unit.

## 1.1 Specification

The core waveform generator is uses Direct Digital Synthesis to create standard and arbitrary waveforms with accuracy based on a crystal oscillator. Amplitude and offset are controlled by DAC hardware independent of the core waveform generator, so that the waveform vertical resolution remains at 256 points regardless of amplitude or offset.

The waveform can be adjusted in frequency in steps of 0.03Hz (more precisely, 0.031247735Hz) over a total range of 0.1Hz to 10MHz (sine) or 3MHz (all other waveforms).

The default upper limit is shown as 3MHz. This may be changed by the operator. Recommended maximum for a sine wave is 10MHz. Recommended maximum for other waveforms (square, ramp, triangle) is 3MHz. An arbitrary waveform may contain spectral content up to a maximum of 10MHz. Maximum and minimum frequency can be set to any points within that range. For example, the range can be set as 20Hz to 20kHz for audio work. The characteristic curve of the control may be set to logarithmic or linear.

The frequency may be set to sweep manually or automatically between the two limit frequencies, with adjustable sweep rate and frequency increment.

### **Core Waveform Generator**

Architecture	Direct Digital Synthesis (DDS)
Clock rate	134MHz
<b>Waveform</b>	
Vertical resolution	8 bits, independent of amplitude or offset
Amplitude	$\pm 10\text{V}_{\text{p-p}}$ max, adjustable with 8 bit resolution
Offset	$\pm 10\text{V}$ max, adjustable with 8 bit resolution
Maximum output	$\pm 10\text{V}$ , signal plus offset
Output impedence	150 ohms
Sine wave signal-Noise	$>48\text{db}$ S/N, independent of output amplitude or offset
Square wave rise and fall time	24nSec
Waveform timebase	256 points
Types	Sine, square, triangle, ramp, noise, arbitrary
Arbitrary waveform	8 bit vertical by 256 time points
Noise waveform	Digital, 32 bit sequence generator, clock 134.208MHz
<b>Frequency</b>	
Range, sine	0.031Hz to 10MHz, resolution 0.1Hz
Range, others:	0.031Hz to 10MHz, resolution 0.1Hz
Resolution	0.031Hz
Control	Manual or automatic sweep
Control curve	Linear or Logarithmic characteristic
Frequency limits	Minimum and maximum frequencies are settable
<b>Frequency sweep</b>	
Mode	Linear or logarithmic characteristic
Direction	Initial direction up/down, start top/bottom frequency
Sweep time step	250mSec to 5000mSec per step
Sweep step magnitude	User entered linear increment or log multiple
<b>Others</b>	
Output	Enable/disable
Computer control	All controls are remotely operated from the host PC

### **Waveform Generator Trigger**

Mode	Free-Running, Triggered
Output	Continuous, Tone Burst
Source	External, Manual, Counter input, Counter Threshold
Cycles	On, off, repeat

## **1.2 Basic Operation**

In this section, we assume that the software has been installed successfully. The hardware is plugged into a USB port and the GUI indicates `Connected`.

On the hardware, the left (green) LED indicates `POWER`. The right is a dual LED, which flashes with each command. When connected to the GUI, this LED lights more-or-less continuously.

## **1.3 Graphical User Interface**

The full GUI is shown in figure 1. The main panel (the *core generator*) is on the left. There are four *subsidiary panels* to the right, each with an X closer in the upper right corner. When the subsidiary panels are not being used,

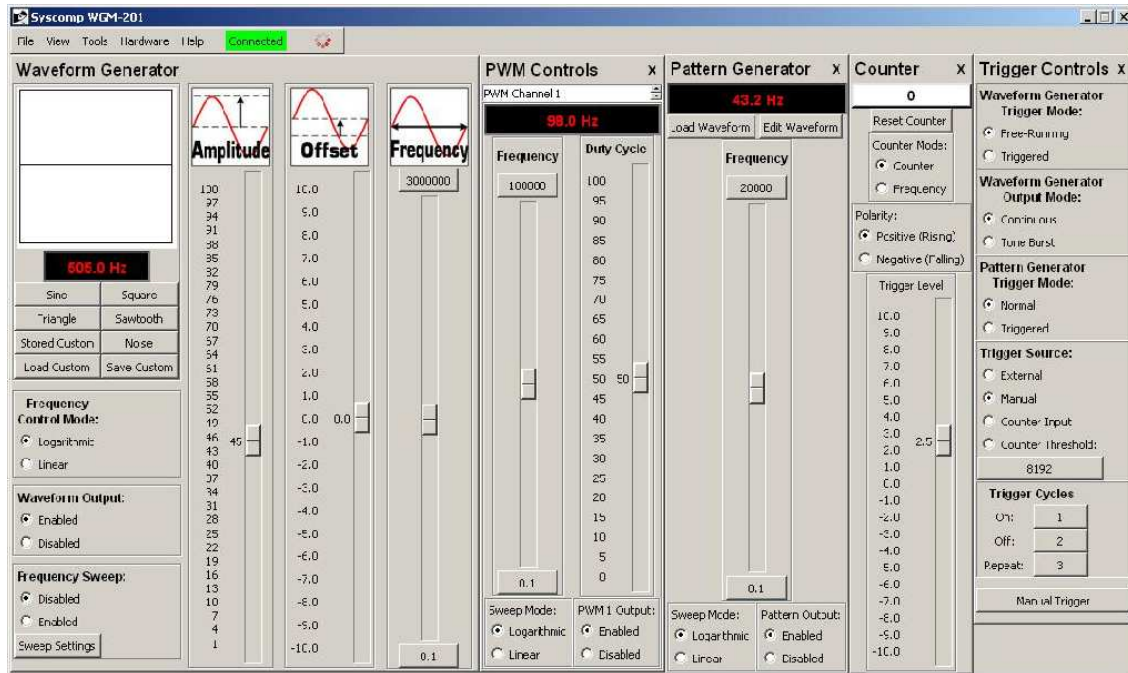

Figure 1: WGM-201 Graphical User Interface

they may be hidden to minimize screen space. Click on the X closer in the upper right corner to hide a panel. It is replaced by a button on the main panel. Figure 2 shows all the subsidiary panels hidden. Notice the buttons in the upper-right corner - they restore the subsidiary panels.

## 1.4 Manual Frequency Setting

There are three methods of setting the output frequency.

1. Set the output frequency by moving the Frequency slider. The output frequency is shown in the frequency readout display, to the nearest 0.1Hz. The total frequency range of the frequency slider is established by the maximum and minimum frequencies shown at the top and bottom of the slider. Left-click on one of these to enter a new value.
2. Move the frequency slider incrementally up or down with a left-click in the track area (the non-button area) of the frequency slider.
3. Left-click on the frequency readout display. A data entry widget pops up. Type in the desired frequency. Left-click on OK.

## 2 Frequency Sweep

Frequency may be swept manually or automatically.

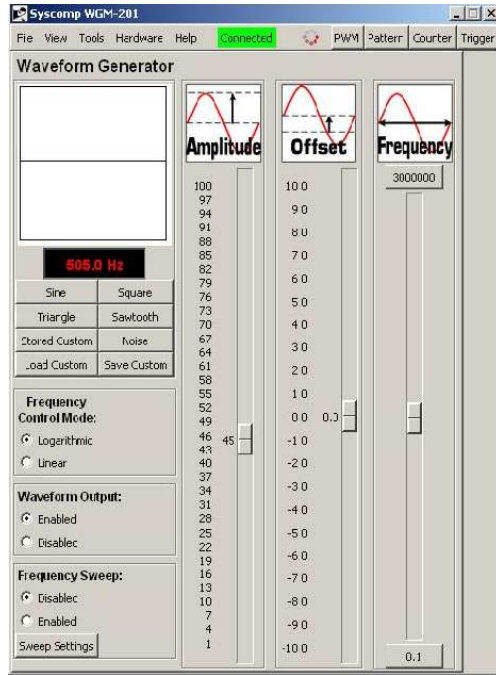

Figure 2: Minimum User Interface

## 2.1 Manual sweep

- Click on the upper frequency limit (at the top of the frequency slider) and enter the maximum frequency of the sweep in Hertz, eg 20000.
- Click on the lower frequency limit (at the bottom of the frequency slider) and enter the minimum frequency of the sweep in Hertz, eg 20.
- Now drag the frequency slider between the bottom and the top limits. The frequency will sweep between 20Hz and 20kHz as the slider is moved.

The characteristic (Frequency Control Mode) of the frequency slider can be switched to Logarithmic or Linear.

In linear mode, the frequencies between maximum and minimum are spread evenly over the range of the slider. In the default state, this means that 3MHz is at the top of the slider, 1.5MHz at the mid point, and 300kHz at 10% from the bottom. The bottom end of the scale is very compressed.

In logarithmic mode, the frequencies are distributed like the keys on a piano. This is a more natural arrangement for human hearing and means for example that each decade (frequency  $f$  to frequency  $10f$ ) occupies the same linear space on the slider<sup>1</sup>. Consequently, it's much easier to use to set a given frequency.

Logarithmic sweep mode has another advantage. Many response curves have linear segments when the amplitude is measured in decibels (another logarithmic scale) and the frequency is a logarithmic scale. This simplifies interpreting the result of a frequency sweep.

<sup>1</sup>Signal generators of the past have used an approximation of the logarithmic control. There was a Range switch, which selected the frequency in multiples of 10, and a Tune knob, which varied the frequency in a linear fashion over each range. The sweep was generally limited to a range of 10:1. A few special-purpose instruments could sweep the audio band 20Hz to 20kHz, a range of 1000:1. The WGM-201 has a maximum sweep range of  $10^7 : 1$  and can also sweep over a very narrow range.

## 2.2 Automatic Sweep

The WGM-201 can automatically sweep the output frequency over its entire frequency range or some part thereof.

- Click on the upper frequency limit (at the top of the frequency slider) and enter the maximum frequency of the sweep in Hertz, eg 20000.
- Click on the lower frequency limit (at the bottom of the frequency slider) and enter the minimum frequency of the sweep in Hertz, eg 20.
- Click on the Sweep Settings button to open up the Frequency Sweep Settings control panel, figure 3.
- In the Frequency Sweep Settings control panel:
  - Select Linear or Logarithmic sweep. Logarithmic is most useful.
  - Select the Frequency Time Step using the slider. The generator produces a series of frequencies, stepping from one to the next. This control sets the time interval between frequency steps, ranging from 50mSec to 5 seconds. A slower sweep is required for example when sweeping a device with a high-Q resonance.
  - Choose the Frequency Step Setting.

For a linear sweep, click on the Linear Step button and enter the frequency increment between each output frequency. For example, if this is set to 10, then the frequency will increment by 10Hz with each new output.

For a logarithmic sweep, click on the Logarithmic Step button and enter the frequency increment between each output frequency. For example, if this is set to 1.2, then each new frequency is 1.2 times the previous frequency. This produces output frequencies that are equally spaced on a logarithmic frequency scale.
  - Select the Initial Sweep Direction: Up or Down. (This control only applies for the Sweep Behaviour 'Cycle Up and Down'. It is disabled for all other Sweep Behaviour settings.)
  - Select the Sweep Behaviour:
    - \* Cycle Up Down sweeps at the same speed when increasing and decreasing frequency.
    - \* Sweep Up, Reset sweeps increasing in frequency and then resets to the starting frequency, waiting for a trigger signal. To trigger the sweep manually:
      - Move to the Frequency Sweep Settings pannel, Sweep Trigger section.



Figure 3: Sweep Mode Control Panel

- Select Manual Enable/Disable.
- Move to the main waveform generator screen, Frequency Sweep controls. Click on Enabled.
- The sweep executes once (as indicated by movement of the Frequency slider). At the end of the sweep, the indicator returns to Disabled. Click on Enabled to repeat the sweep.

To trigger the sweep from an external signal, see below *Sweep Trigger Input*, section 2.2.3.

- \* Sweep Up, Repeat sweeps increasing in frequency, resets to the starting frequency and then repeats (no trigger signal required).
- \* Sweep Down, Repeat sweeps decreasing in frequency and then resets to the starting frequency, waiting for a trigger signal. To trigger the sweep manually, see above Sweep Up, Reset. To trigger from an external signal, see below, *Sweep Trigger Input*, section 2.2.3.
- \* Sweep Down, Repeat sweeps decreasing in frequency, resets to the starting frequency and then repeats (no trigger signal required).

### 2.2.1 Continuous Sweep

If you selected Cycle Up Down, Sweep Up, Repeat or Sweep Down, Repeat, to start the sweep move to the main waveform generator screen, Frequency Sweep controls. Click on Enabled. The generator will now sweep between the two limits. The position of the Frequency slider moves to indicate progress of the sweep.

### 2.2.2 Sweep Trigger Output

When 'Enable Sweep Trigger Out (PWM2) is checked, a logic level sweep trigger signal is available at the PWM2 output terminal on the rear panel connector. This signal could be used by an oscilloscope to cause the beam of the scope to start at the same time as the beginning of a frequency sweep.

The signal is logic high during sweep up and logic low during sweep down. This signal can be most easily seen when the Sweep Behaviour is set to 'Cycle Up Down'. On the main control panel, set Frequency Sweep: to Enabled. The Frequency slider should move up and down and the output frequency change. The sweep trigger signal then readily visible.

During Sweep Behaviour: Sweep Up, Repeat or Sweep Behaviour: Sweep Down, Repeat the logic level signal goes low for about 50mSec during the sweep reset.

### 2.2.3 Sweep Trigger Input

The sweep may be initiated by a logic level signal applied to the Counter/Trigger BNC input connector on the front panel of the unit. This can be useful in synchronizing the sweep generator to an external device such as an oscilloscope.

To trigger the sweep:

- In the Frequency Sweep Settings panel under Sweep Trigger select Counter Trigger Input.
- In the Counter panel under Trigger Level, select a suitable level. For example, the default of 2.5 volts is appropriate for many logic level signals greater than 2.5 volts. The trigger voltage may be larger than +5 volts, as much as 10 volts. Internal clamps will protect the trigger circuitry. For example, a 9 volt battery makes a convenient trigger signal.
- Any of the Sweep Behaviour modes can be triggered. In the Repeat modes (Cycle Up Down, Sweep Up Repeat, Sweep Down Repeat), one trigger initiates sweeps, which will then continue indefinitely without further triggers. In the Reset modes (Sweep Up Reset, Sweep Down Reset), one trigger initiates one sweep and reset.

- During the frequency sweep, the Frequency slider moves and the Disabled/Enabled button on the main panel changes from Disabled to Enabled.

### 3 Tone Burst

These controls are in the Trigger Controls panel, figure 4.

- For normal continuous waveform output operation of the generator, set Trigger Mode to Free-Running and Output Mode to Continuous. (This is the power-on default setting.)
- For continuous generation of tone bursts, set Trigger Mode to Free-Running and Output to Tone Burst. The tone burst pattern is specified by the Trigger Cycles On, Off settings. Trigger Cycles On sets the number of complete cycles in the burst. Trigger Cycles Off sets the number of cycles between bursts. Trigger Cycles Repeat has no effect. The maximum count for Trigger Cycles On and Trigger Cycles Off is 65535.
- For manually triggered generation of a tone burst, set Trigger Mode to Triggered and Output Mode to Tone Burst. Set Trigger Source to Manual.

The tone burst pattern is specified by the Trigger Cycles On, Off settings. Trigger Cycles On sets the number of complete cycles in the burst. Trigger Cycles Off sets the number of cycles between bursts.

Trigger Cycles Repeat effectively sets the number of tone bursts. The total number cycles is constrained, according to the following:

$$(N_{on} + N_{off}) \times N_{repeats} < 2^{16}$$

where

- $N_{on}$  is the number of ON cycles in each burst
- $N_{off}$  is the number of OFF cycles in each burst
- $N_{repeats}$  is the number of tone burst repeats.

A tone burst is best observed with a digital storage oscilloscope set to Single Shot. On the generator, set up the tone burst configuration as above. Set the scope to single-shot triggering. Reset the scope sweep. Actuate Manual Trigger on the generator. The scope should capture the desired tone burst.

Figure 5 shows these tone bursts captured by a Syscomp CGR-101 CircuitGear oscilloscope in single-shot mode.

#### 3.1 Triggered Tone Burst

It is possible to use an external trigger signal to initiate each tone burst from the WGM-201 generator. Here is an example configuration. In this example, we describe a configuration using the CircuitGear CGR-101 generator to provide the trigger signal and the CircuitGear CGR-101 oscilloscope to display both the trigger signal and tone burst. However, any generator that can produce a suitable trigger signal may be used to provide the signal. Any oscilloscope may be used to observe the trigger and tone burst.

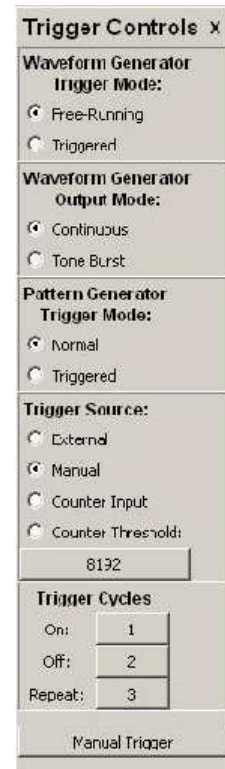

Figure 4: Trigger Controls Panel

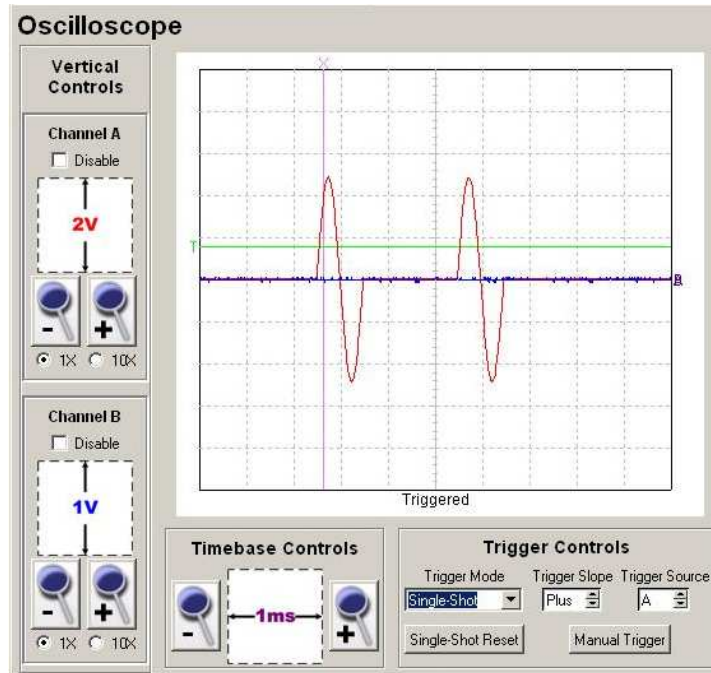

Figure 5: Tone Burst Oscilloscope Display

1. Start both the CGR-101 software and WGM-201 software. The screen will be rather crowded at that point. You can minimize the program you are not using at any given instant. You can also minimize the Pulse Controls and Pattern Generator panels of the WGM-201, since they are not needed for this exercise.
2. The tone burst trigger signal originates in the CGR-101. Connect the CGR-101 generator output to Channel A of the CGR-101 scope, so that you can see the trigger signal. Connect that same signal to the front panel counter/trigger input BNC connector on the WGM-201 generator.
3. At the trigger source (the CGR-101 generator) set a waveform frequency of about 20Hz or so to start with. Set the amplitude to 55 ( $\pm 1V$ ) and the waveform to square wave. Trigger the scope from this signal. Check that this signal appears on Channel A of the CGR-101 oscilloscope.
4. Connect the output of the WGM-201 generator to channel B of the CGR-101 scope.
5. Check that WGM-201 waveform generator trigger is operating properly:
  - On the 'Counter' panel, Counter Mode, select 'Event'.
  - On the same panel, adjust the trigger slope and level until you see the counter readout (at the top of the panel) incrementing.
6. Set up the Trigger Controls panel:

**Waveform Generator Trigger Mode** Triggered

**Waveform Generator Output Mode** Tone Burst

**Pattern Generator Trigger Mode** (shouldn't matter)

**Trigger Source** Counter Input (Do not select External, that input is on the rear panel of the WGM-201, and accepts a logic signal.)

7. For a tone burst of 3 on, 2 off, set:

**On** 3

**Off** 2

**Repeats** 1

8. Set the WGM-201 waveform generator amplitude output to 18 ( $\pm 1V$ ), frequency to 112 Hz or so.

On the oscilloscope display, you should see a burst of 3 cycles coincident with the rising edge of the square wave trigger, with very little delay between the trigger signal and start of the tone burst.

Now that you have a basic tone burst configuration operating, you can change the control parameters to the values you want.

## 4 Pulse Generator

The instrument has two independent pulse generators. For each generator, the duty cycle and frequency can be set independently. That is, changing the duty cycle has no effect on the frequency and vice versa.

The duty cycle is defined as the ratio of ON time to the period of the waveform. During the ON time, the waveform is at +5V. During the remainder of the period (the OFF time) the waveform is at zero volts.

- Adjusting duty cycle independent of frequency is useful when testing certain types of switch mode power supplies and power control circuits.
- An adjustable duty-cycle waveform may be used as the basis for digital to analog conversion. If the waveform is low-pass filtered, the resultant average is proportional to the duty cycle.
- Spectrum analysis of a variable duty cycle signal is illustrative of the principles of Fourier Analysis.

Each pulse generator output has its own control panel, figure 6. One of these control panels is visible at a time, selected by a switch at the top of the panel, which shows Channel 1 or Channel 2.

Pulse generator output signals swing from 0V to +5V. The two signals and ground connections are available on the rear-panel connector of the instrument (section 10).

The pulse generator controls are identical for Channel 1 and Channel 2.

The output is enabled or disabled by radio-buttons under PWM1 (or-PWM2) Output: When an output is disabled, the frequency and duty cycle sliders are frozen.

As in the case of the core waveform generator, the frequency may be set by direct entry. Left-click on the frequency display in the pulse generator panel. This causes an entry widget to appear. Enter the desired frequency and then left-click on OK.

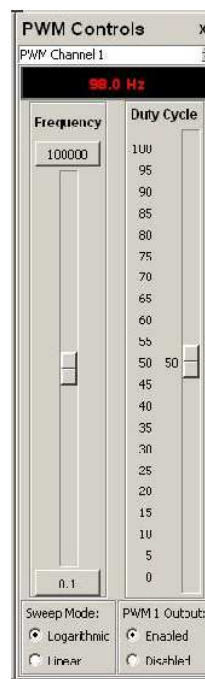

Figure 6: Pulse Generator Control Panel

The frequency slider operates in the same manner as the core waveform generator. The control may be dragged between the maximum and minimum values. Clicking on the slider area outside the button causes the frequency to increment or decrement. The maximum and minimum frequencies are set by clicking on their respective displays and typing in suitable values. The Sweep Mode (control characteristic) may be selected as logarithmic or linear.

A second slider sets the duty cycle of the output waveform.

In general, the pulse generator outputs are unsynchronized with each other and the main generator output. However, if the two pulse generator frequencies are set to the same value, they will remain in a fixed (although arbitrary) phase relationship. This is also true if one pulse generator output frequency is an integer multiple of the second output. The two frequencies can also be made to *walk* with respect to each other. For example, if one frequency is set to 400.0 Hz and the other to 400.1 Hz, then the two frequencies will appear to drift past each other, one complete cycle every 10 seconds.

Similarly, the two pulse generator outputs will synchronize with the main output if they are set to exactly the same frequency.

## 5 Pattern Generator

The pattern generator produces a series of 8 bit data words at the rear panel connector (section 10 on page 20). The sequence length may be any binary value from 4 to 1024 words.

The pattern generator is controlled from the Pattern Generator Control Panel, figure 7. The frequency slider sets the frequency of the repetition rate of the sequence. For example, if the sequence length is set to 32 words and frequency slider set to 1000Hz, then the 32-word sequence will repeat 1000 times per second. The maximum bit toggle rate is 10MHz.

The software automatically calculates and adjusts the maximum pattern frequency to keep the sample rate below 10MHz. i.e. The maximum frequency for a 1024 sample pattern is 20kHz, 40kHz for a 512 sample pattern, 80kHz for a 256 sample pattern, etc.

The rear-panel pattern-generator trigger signal goes to logic low at the beginning of each sequence and high approximately half-way through the sequence. This is true for any pattern length.

As in the core waveform generator and pulse generator controls, the frequency may be set by direct entry (click on the frequency display), by dragging the slider, or by clicking in the slider area outside the button. The maximum and minimum frequency settings may be changed by clicking on them and entering new values.

### 5.1 Creating a Digital Pattern

We'll use an example to illustrate this process. We assume that our digital logic needs 7 shift pulses on one pin, followed by a load pulse on another pin.

1. Click on the Pattern Generator panel Edit Waveform button.
2. The pattern editor panel displays.



Figure 7: Pattern Generator Control Panel

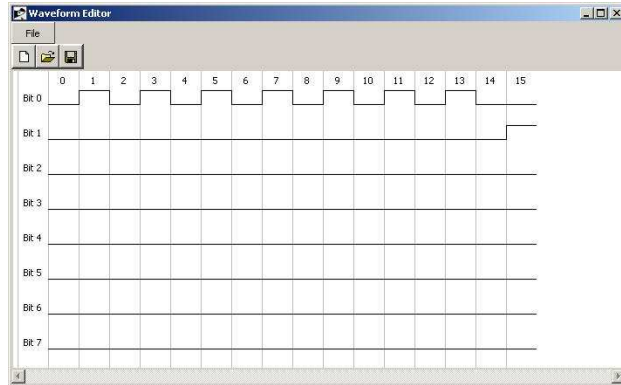

Figure 8: Pattern Editor

3. Click on the pattern editor 'blank sheet' icon.
4. The New Waveform Select Sequence Length panel appears. Select the desired sequence length. in this case we select a sequence length of 16.
5. The pattern editor panel displays 8 traces with timing marks from 0 to 15.
6. Click on a bit cell to change its state from zero to one or vice versa.
7. On the Bit 0 line, create 7 logic ones in a sequence, each separated by a logic zero.
8. On the Bit 1 line, create a single logic 1 in the #15 time slot. The pattern editor should appear as in figure 8.
9. Click on the floppy disk icon and save the file.
10. Return to the Pattern Generator panel and click on 'Load Waveform'. In the load dialog, select the previously saved file.
11. The pattern should now appear at the rear panel connector.

The resultant computer display, captured by a Syscomp CGR-101 oscilloscope, is shown in figure 9. The upper trace shows 7 shift pulses in sequence. The lower trace shows the single load pulse.

## 5.2 Pattern File Format

The pattern file is a text file, so it can be edited in any text editor (such as Notepad on a Windows machine). The first entry is the number of time slots (16 in our example). This is followed the one byte value for each time slot entry. In our example, the last entry is '2' because there is a single binary 1 on the Bit 1 line, which has a binary weight of 2.

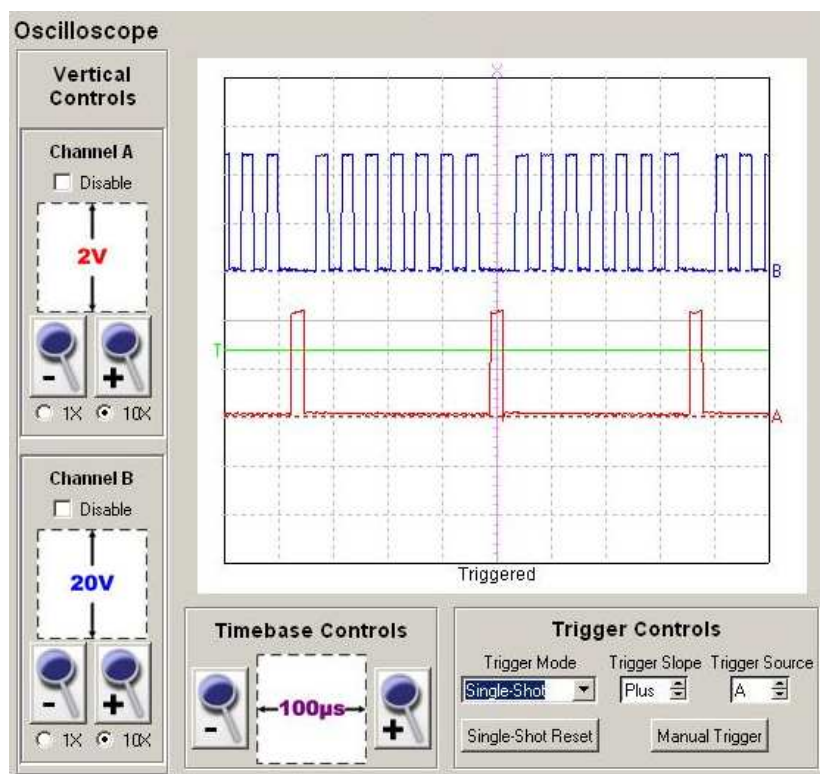

Figure 9: Pattern Demonstration

## 6 Counter

The Counter is a general purpose event and frequency counter. In the Events mode, the counter increments with each trigger pulse, up to a maximum of  $2^{31} - 1$  (approximately  $2 \times 10^9$ ) counts. A manual reset restarts the counter from zero.

The counter input connector is the right-hand BNC connector on the front panel.

In the Frequency mode, the counter measures the input frequency to an accuracy of  $\pm 50$  ppm ( $\pm 0.005\%$ ).

Counter trigger controls allow one to select the slope of the trigger (rising or falling edge) and the voltage ( $\pm 5$ V, approx.)

The counter input signal, processed by the trigger slope and level, can be used to trigger a tone burst. Select Trigger Source: Counter Input.

This same trigger signal can be conditioned to delay a number of selected cycles. For example, one could set up the generator to produce a tone burst when 1000 events have occurred. Select Trigger Source: Counter Threshold. Click on the numbered button below Counter Threshold. An entry widget pops up. Enter the number of cycles in that entry.

Counter threshold triggers only once and then must be manually reset.

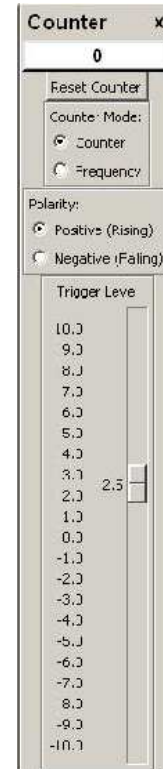

Figure 10: Counter Panel

## 7 Arbitrary Waveform

A waveform for the WGM-201 is stored as a text file consisting of 256, 8 bit bytes with a .dat suffix. Look for `sine.dat` as an example. Most negative value of a waveform is coded as 255. Most positive value is coded as 0.

Any program that can create this type of file can be used to create waveform. For example, you could hand-code the file using a text editor program like Notepad, although this would be rather tedious.

If the waveform can be described by a formula, then you can use a spreadsheet to create the necessary file. Use the formula to create 256 values of the waveform such that all the values are in the range  $0 < x < 255$ . Copy the waveform values to a new sheet. Save that sheet as a .csv format file. Review the file in an editor and remove any extraneous characters by search and replace.

When creating and generating an arbitrary waveform, Keep in mind the constraints described in sections 7.1 and 7.2, below.

### 7.1 Low and High Frequency Settings

At low frequency, the waveform memory address remains constant for a number of clock cycles. As a waveform is produced, all the addresses in the waveform memory are accessed, in ascending order, each for several clock cycles. Consequently, the waveform includes 256 horizontal steps.

At some intermediate frequency, each and every clock pulse results in an increment of the waveform address. Each point on the waveform is produced exactly once. At this frequency (call it  $f_{mid}$ ), the period of the generated waveform (call it  $T_{mid}$ ) is given by:

$$T_{mid} = \text{Points in one waveform} \times T_{clock}$$

$$\begin{aligned}
&= 2^8 \times 600 \text{ nsec} \\
&= 154 \mu\text{sec}
\end{aligned}$$

This period corresponds to a frequency of:

$$\begin{aligned}
f_{mid} &= \frac{1}{T_{mid}} \\
&= \frac{1}{154 \mu\text{sec}} \\
&= 6493.5 \text{ kHz}
\end{aligned}$$

Above that frequency, some addresses in the waveform memory are skipped. As a result, the waveform contains fewer than 256 horizontal points.

At very high frequencies, the number steps in the waveform decreases to the point that the waveform steps become visible. The waveform becomes 'blocky'. There is a tradeoff between the quality of the waveform and the maximum useable frequency of operation.

In this generator, the default maximum frequency (seen at the top of the frequency slider) has been set at 3MHz. This is under the control of the user. Click on that display and enter a new maximum value. Quite satisfactory sine waves can be obtained at 10MHz.

## 7.2 Detail in Arbitrary Waveforms

The basic nature of a sampled-data system the lowpass filter in the signal chain places a restrictions on the shape of the arbitrary waveform. The highest frequency content in the arbitrary waveform cannot exceed the capability of the output amplifier in the generator. As a rule of thumb, the highest reproduced frequency should be less than the maximum generator sine wave frequency, which is 10MHz.

For example, suppose the arbitrary waveform consists of a four cycles of a sine wave. When the frequency is set to 10MHz, the effective output frequency is 40MHz, which is beyond the capability of the generator output amplifier.

You are free to experiment with this, to see if the generator can reproduce the required detail at the maximum operating frequency.

## 7.3 Waveform Editor

John Foster has developed the *Wavemaker* program to allow editing of a generator waveform, using a graphical user interface. *Wavemaker* is started from the *Tools* menu. The *Wavemaker* manual is available from the *Help* manual.

# 8 Synchronizing Two Generators

Two or more generators may be synchronized. On their rear panel connectors, the waveform trigger out pin of generator #1 (the master) is connected to the waveform trigger in pin of generator #2 (the slave).

The slave generator must be set to a very slightly higher frequency than the master, so that each waveform cycle completes before there is a new trigger signal<sup>2</sup>.

Figure 11 shows the master waveform producing a 400Hz square wave. The slave is producing a 400Hz sine wave<sup>3</sup>. The expanded view shows a flat spot on the slave waveform where it is waiting for the next trigger signal.

<sup>2</sup>This is triggered operation, not a phase-lock. Changing frequency requires changing frequency on both master and slave.

<sup>3</sup>On the todo-list is a control for *jogging* the phase of the two waveforms.

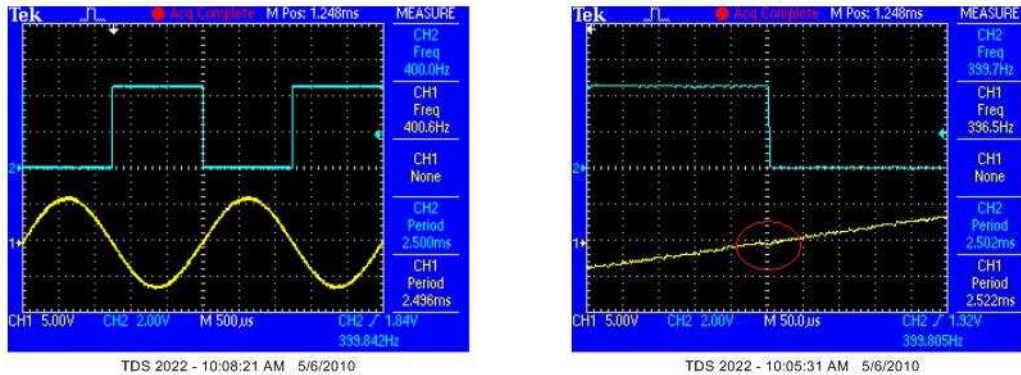

(a) Waveforms

(b) Expanded View

Figure 11: Synchronized Waveforms

## 9 Commands

In this section we document commands that may be issued directly to the hardware. The terminal emulator or programming language that sends these commands appears to do so using a serial port connection to the hardware. It is not necessary to deal with USB in any form. Consequently, any language that can send and receive commands via a serial port can communicate with the WGM-201 hardware.

### 9.1 Setting up the Terminal

We recommend first testing the connection using a terminal emulator. A terminal emulator (such as Hyperterminal in Windows or Seyon or Minicom in Linux) can be used to send commands to the hardware, and this verifies that the serial connection is working properly.

When the WGM-201 software is running correctly (ie, Connected), actuate Hardware -> Connect -> Port Settings and determine the COM port (serial port) being used by the GUI (graphical user interface).

Shut down the GUI so that it's not trying to use the serial port. The serial port needs to be available to the terminal emulator program.

Start the terminal emulator and connect to that COM port. (On a Linux machine it's probably a `tttyUSBx` port, where x is the number of the port.) Set the terminal emulator parameters to 8 bits, no parity, one stop bit. Since the serial port is a VCP (virtual COM port) that is actually USB, the baud rate is unimportant.

With the WGM-201 hardware connected, you should now be able to send commands to the hardware. The first command to try is the `Identify` command. Send `i` followed by a carriage return. The right-hand LED on the hardware should flash, since the hardware received a character and has sent a string. The identification string (see table, below) should appear on the terminal screen.

### 9.2 Command Listing

The commands that are used to control the WGM-201 hardware are shown in the following tables.

All commands are terminated by a carriage return character. A terminating line-feed character is ignored.

<b>General</b>	
i	Identification string request. Returns: *Syscomp Advanced Waveform Generator VX.XX where X.XX is the firmware revision.
<b>Function Generator</b>	
A	Amplitude, sets peak voltage of waveform. Usage: A nnn where nnn is an 8 bit ascii number ranging from 0 to 255, representing the amplitude. Output amplitude = $(nnn/255) * 10V$ Example: A 127 sets the amplitude to 5 volts.
F	Frequency Command. Usage: F aaa bbb ccc ddd where aaa through ddd are 8 bit ascii numbers that make up a 32-bit number (YYYY) to set the output frequency. Output frequency = $YYYY * 0.031247735 [Hz]$ (See below for an example).
O	Offset command. Usage: O nnn where nnn is an 8 bit ascii number representing the offset. Output offset = $((127 - nnn)/127) * 10V$
W n	Select waveform, where n is one of the following. 0 - Sine 1 - Triangle 2 - Square 3 - Sawtooth 4 - User
S a d	Write volatile [1] waveform sample into device. a - eight bit address d - eight bit data
J a d	Write semi-permanent [1] waveform sample into device buffer memory. a - eight bit address d - eight bit data
Q	Write the data loaded into the buffer (with the J command) to the non-volatile memory.
U	Recall waveform from the non-volatile memory. Also returns the entire waveform (256 bytes) preceeded by the W character
E	Enable waveform output [2]
D	Disable waveform output
N	Enable noise output [2]
n	Disable noise output

<b>Trigger Commands</b>	
M n	Select trigger mode, where n is one of the following. 0 - Waveform Generator Free-Running Mode 1 - Waveform Generator Triggered Mode 2 - Pattern Generator Free-Running Mode 3 - Pattern Generator Triggered Mode
V 0	Select continuous output
V 1	Select tone burst output
X n	Select trigger source, where n is one of the following. 0 - External Trigger 1 - Manual Trigger 2 - Counter Trigger 3 - Counter Input
Y a b	Set trigger count command Parameters a and b make up a 16 bit number which determines how many waveform or pattern generator cycles are executed in triggered mode.
Z a b	Set tone burst ON cycles Parameters a and b make up a 16 bit number which determines how many waveform cycles are output in tone burst mode.
z a b	Set tone burst OFF cycles Parameters a and b make up a 16 bit number which determines how many waveform cycles the generator is idle in tone burst mode.
T	Manual Trigger Command
L a b c d	Counter trigger threshold command Parameters a b c d make up a 31 bit threshold value for the counter. Byte a is the MSB, byte d is the LSB. When the counter value exceeds this threshold a counter trigger is generated which can be used to trigger the waveform generator or pattern generator
<b>PWM Commands</b>	
P c n	PWM Duty Cycle Command Parameter c is the channel number, either 1 or 2. Parameter n is an eight-bit duty cycle value: Duty Cycle = $(255 - n)/255 * 100\%$
G e a b c d	PWM Frequency Parameter e is the channel number, either 1 or 2. Parameters a b c d specify the frequency. (See Frequency command, and example below.
1	Enable PWM 1 output
!	Disable PWM 1 output
2	Enable PWM 2 output
@	Disable PWM 2 output

<b>Pattern Generator Commands</b>	
3 #	Enable Pattern Generator Output Disable Pattern Generator Output
H a b c d	Set Pattern Generator Frequency (frequency of the repetition rate of the sequence.) Parameters a b c d specify the frequency. See Frequency Command above.
B h l d	Set Pattern generator sample Enters a pattern value d at pattern address h.l where h is the high byte, l is the low byte.
l n	(the command is lower case 'ell') Pattern Generator Length. The parameter n specifies the pattern length, as follows: 0: 1024 samples 1: 512 samples 2: 256 samples 3: 128 samples 4: 64 samples 5: 32 samples 6: 16 samples 7: 8 samples 8: 4 samples 9: 2 samples
<b>Counter Commands</b>	
D n	Counter Mode 0: Normal Counter (Accumulator) 1: Frequency Counter (Period = 1/64 sec) 2: Frequency Counter (Period = 1/32 sec) 3: Frequency Counter (Period = 1/16 sec) 4: Frequency Counter (Period = 1/8 sec) 5: Frequency Counter (Period = 1/4 sec) 6: Frequency Counter (Period = 1/2 sec) 7: Frequency Counter (Period = 1 sec) 8: Frequency Counter (Period = 2 sec)
C nn	Counter Trigger Voltage Level where nn as an 8 bit ASCII value representing the trigger threshold voltage: Trigger Level = $(nn - 127)/127 * 10$ volts
R	Read Counter Returns 4 bytes corresponding to the 32 bit counter value, high byte first.
r	Reset Counter
+	Sets trigger polarity to rising edge.
-	Sets trigger polarity to falling edge.

Notes:

[1] A *volatile* sample is one sample of the arbitrary waveform. It is volatile because it is held in RAM, so it disappears when the power is disabled. A total of 256 8 bit samples constitute a waveform and will show as the current output waveform.

A *semi-permanent* sample is written into the hardware EEPROM. It does not appear immediately in the output waveform. It is transferred into the waveform RAM and appears in the output with the *Select* waveform - User command W 4.

[2] Enable Waveform output enables and disables *all* waveforms, including noise. Enable Noise enables and

disables only the noise source. When noise is enabled, other waveforms (such as Sine) are disabled and vice versa.

### Converting Frequency

Here we show the example of converting output frequency of 2MHz into a command.

1. Convert the desired output frequency into the correct count, using the conversion factor.

$$\begin{aligned} 2\text{MHz} &= \frac{2 \times 10^6 \text{ Hz}}{0.031247735 \text{ Hz/Count}} \\ &= 64004639 \text{ Counts} \end{aligned}$$

2. Convert this value to a hexadecimal number. (Some scientific calculators have this function, or use the web site <http://www.statman.info/conversions/hexadecimal.html>)

$$64004639 \text{ base } 10 = 3d0a21f \text{ hexadecimal (base } 16)$$

3. Group the hex number by pairs starting at the right end. Convert each pair to the corresponding decimal number, which will range from 0 to 255. Again, use a calculator for each pair, or the website mentioned previously.

$$\begin{aligned} 3d0a21f &= 3 \text{ d0 a2 1f} \\ &= 3 \text{ 208 162 31} \end{aligned}$$

You can verify that this is correct. Use `View -> Debug Console` to enable the console, which shows messages being sent to the hardware. Click on the frequency readout, enter the frequency value 2000000 into the New Frequency widget. You will see the message `F 3 208 162 31` sent to the hardware.

Trigger	
M n	Select trigger mode, where n is one of the following. 0 - Waveform Generator Free-Running Mode 1 - Waveform Generator Triggered Mode 2 - Pattern Generator Free-Running Mode 3 - Pattern Generator Triggered Mode
X n	Select trigger source. 0 - External Trigger 1 - Manual Trigger 2 - Counter Trigger
Y a b	Set trigger count command. Parameters a and b make up a 16-bit number which dictates how many waveform or pattern generator cycles are executed in triggered mode. It uses an count up counter which overflows at 65536 so you program it with 65536 minus the number of cycles you want it to output after the trigger. Using <code>Y 0 1</code> would output 65536-1=65535 cycles of the waveform after a trigger.
T	Manual trigger

<b>Pulse Generator</b>	
P c n	pulse generator duty cycle command. Parameter c is the channel number. Valid values are 1 and 2. Parameter n is an eight-bit duty cycle value. 0 is off, 255 is fully on.
G c a b c d	pulse generator frequency. Parameter c is the channel number. Valid values are 1 and 2. Parameters a b c d make up frequency integer (see frequency command)
1	Enable pulse generator 1 Output
!	Disable pulse generator 1 Output
2	Enable pulse generator 2 Output
@	Disable pulse generator 2 Output
<b>Pattern Generator</b>	
3	Enable pattern generator output.
#	Disable pattern generator output.
H a b c d	Pattern generator frequency. (See frequency command)
B h l d	Pattern generator sample command. Parameters h and l are the high and low bytes of a 10-bit address value. Parameter d is an 8 bit sample value.
<b>Counter</b>	
C	Counter threshold. Usage: C nnn where nnn is an 8 bit ascii number representing the counter threshold voltage. Threshold voltage = $((127 - nnn)/127) * 10V$ .
R	Read counter Command returns 5 bytes, Cuvwx where uvwx correspond to a 32-bit counter value, high byte first.
r	Reset counter to zero.
+	Select positive counter trigger polarity
-	Select negative counter trigger polarity

## 10 Rear Panel Connector

The rear panel connector provides access to the following signals:

- Digital Pattern outputs 0 through 7
- Trigger signals for the waveform generator, pattern generator and counter.
  - **Waveform Trigger Out** A logic level signal that goes high at the beginning of each waveform. It goes low at approximately the mid-point of the waveform.
  - **Pattern Generator Trigger Out** A logic level signal that goes low at the beginning of each pattern sequence. It goes high at approximately the mid-point of the pattern.
  - **Counter Trigger Out** A logic level signal that corresponds to the counter trigger signal.
- Pulse Generator outputs (2)
- External trigger input
- Ground

The pinout is shown in figure 12 and on the case label of the instrument.

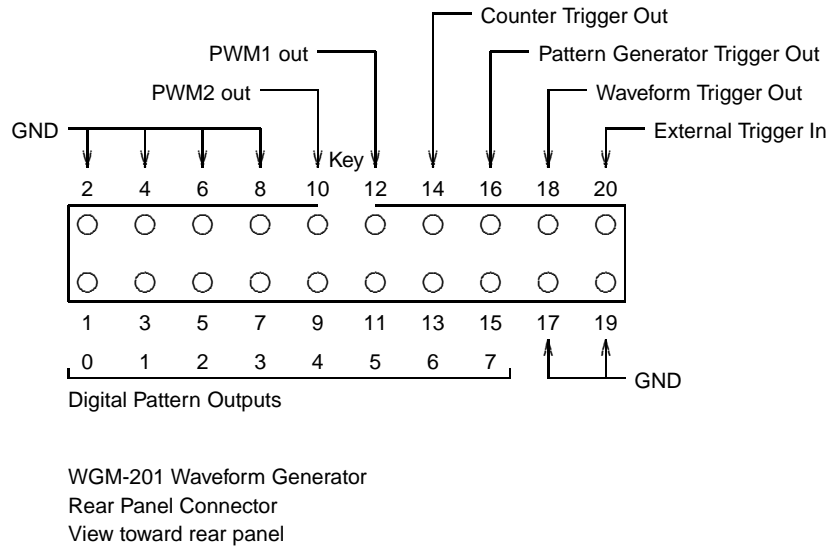

Figure 12: WGM-201 Rear Panel Connector Pinout

## 10.1 Rear Panel Connector Mating Plug

One suitable rear panel connector mating plug is as follows:

MODE part # 35-0202-0  
20 position, 2 row, 0.1" (2.54mm) contact spacing.  
Mates with 20 way 0.050" spacing flat cable.  
Polarizing key (Centre bump)  
Strain Relief

Available from MODE Electronics, <http://www.mode-elec.com>  
Distributed by Active-Tech Electronics in Canada, <http://www.active123.com>

Another suitable connector is this one:

3M part # D89120-0131HK  
Digikey part # MKC20E-ND  
20 position, 2 row, 0.1" (2.54mm) contact spacing.  
Mates with 20 way 0.050" spacing flat cable.  
Polarizing key (Centre bump)  
Contacts 10u gold plate

Mating strain relief for this connector:

3M part # D3448-89120  
Digikey part # MESR20-ND

Available from Digikey, <http://www.digikey.com>

Any flat cable with 0.050" conductor spacing that will mate with IDC (Insulation displacement connector) should be suitable for use with these plugs. For example:

3M 3302 Series  
Digikey part # MCM-20M-5-ND (5 foot length)  
10 colour repeat, clear carrier

## 11 Creating an Arbitrary Waveform

The *WaveMaker Waveform Editor*<sup>4</sup> is available under the `Tools` menu. Select that item and the blank waveform edit screen pops up.

For WaveMake instructions, select the `Help -> Manual (PDF)` on the waveform edit screen. (If for some reason that fails, check in the install directory, `Source` subdirectory. The manual file should be there as a pdf which you can open with Acrobat reader.).

---

<sup>4</sup>Contributed by John Foster. Thanks, John!